



**ADVANTAGES**

- Rugged construction
- Interchangeability filter inserts
- Large surface area and volume of sediment
- Interchangeability magnetic pump/mechanical seal pump (EVOLUTE)
- Excellent resistance at alkaline and acid chemicals
- Filter housing three year warranty

**FEATURES**

- Filter flow rate 15-50 m<sup>3</sup>/h
- Tmax exercise 70°C with 3 bar presure
- PP solid monoblocc filter housing
- Large choice of filtration systems
- Versions: valve between pump and filter housing, precoat tank (100 l) with PP valves group
- Filter papers Ø 350/60 mm

**FILTER ELEMENTS**

The great versatility of the filter unit offers to the operator the possibility to choose between different kinds of filtration or purification with the same unit.

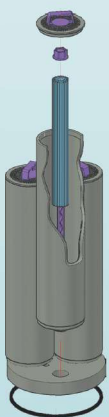

CARBON CANISTER

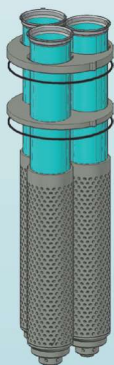

FILTER PACK WITH ABSOLUTE RATE WH BAG PLEATED ELEMENTS OR BAGS

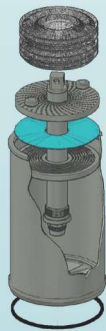

FILTER PACK WITH OILSORB

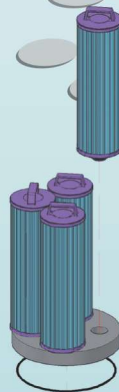

FILTER PACK WITH HIGH FLOW WASHABLE JUMBO CARTIDGES

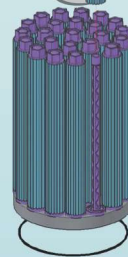

FILTER PACK WITH CARTRIDGES

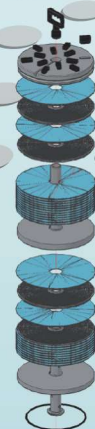

FILTER PACK WITH LOW PROFILE DISCS

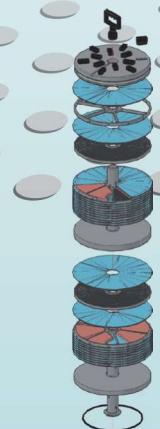

FILTER PACK WITH HIGH PROFILE DISCS

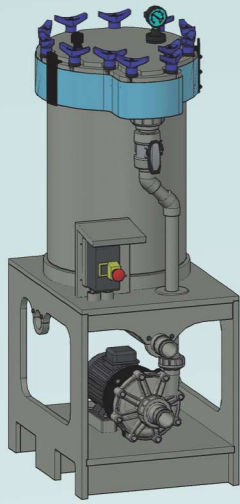

VERSION STANDARD

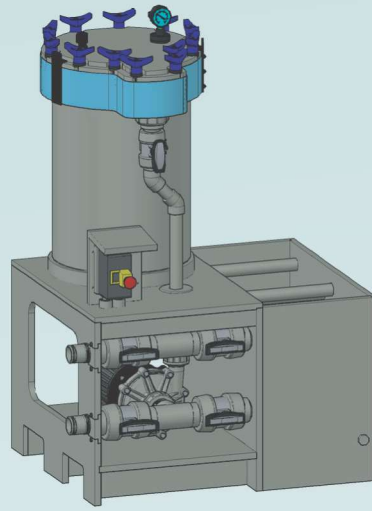

VERSION "PRECOAT TANK"

Mod	FILTER HOUSING							FILTER ELEMENT					PUMP			VERSION	OPTIONAL	
	Discs Dxn° (m²/l)*	Cartridges n° x l"	JUMBO (m²)	WH Absolute rate Pleated bag (m2)	Bags (m2)	Oilsorb (l)	Carbon (l)	Discs D350/60 mm	Cartridges	JUMBO	WH	Bags	Mag drive	Mechanical seal	Mat.	Type	Type	
TOP	24D2 (5/25)	24C2 (24X20)	24P2 (12)	24W2 (12)	24B2 (3)	24O2 (45)	24A2 (24)	_ = paper P = Meraklon T = PTFE	_ = DOE D63 P = DOE D 70	n° 4 cartridges JBP2A D150 mm	n° 3 bags SIZE 1 D 178x410 mm	EVT15 EVT20 EVT25 EVT30	EVM20 O3A2 O3B1 O3B2	_ = PP  F = PVDF	_ = valve between pump and filter  T = pre coat tank (V=100l)	B = By pass pump filter R = splashproof lid ring I = interlock lis sensor P = filter pack replacement system with electric hoist X = stainless steel frame with dropping tank		
	24D2H (5/28)																	
	24D3 (7,5/37)	24C3 (24X30)	24P3 (18)	24W3 (18)	24B3 (6)	24O3 (68)	24A3 (36)		n° 4 cartridges JBP3A D150 mm	n° 3 WH pleated element 30"	n° 3 bags SIZE 1 D 178x813 mm		EVT20 EVT25 EVT30 MPP831				EVM20 O3A2 O3B1 O3B2 O4B3	
	24D3H (7,5/40)																	
TOP	24D2H							P					EVT25			F	T	R

\* m² = surface area / l = volume of sediment

MAGNETIC PUMP 50Hz Rpm2800

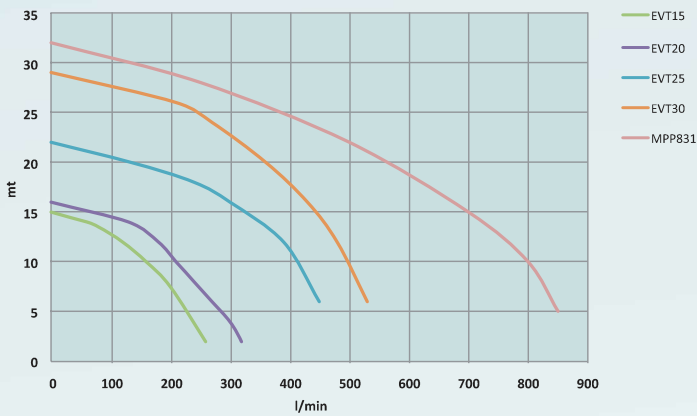

MECHANICAL SEAL 50 Hz Rpm 2800

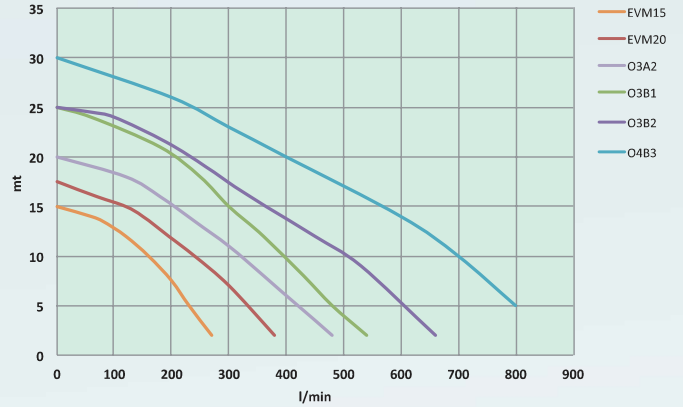

	EVT15 EVM15	EVT20 EVM20	EVT25	EVT30 O3A2	O3B1	MPP831	O4B3
KW	0,7	1,1	1,5	2,2	3	4	5,5
A* 220/380V	3,13/1,7	4,9/2,5	6,5/3,8	8,7/5,0	7,2/5,9	13,2/7,6	20/11,5
A* 400/690V							11,5/6,9

\* data can change accordind with motor type